

GLASS SLIDING FITTING

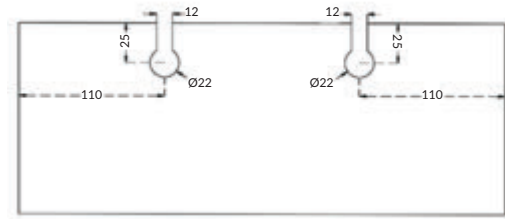

GLASS SLIDING FITTING - GLASS SLIDING ROLLER



Glass Preparation

Features:

- Trouble Free Operation.
- Maximum Door Width : 900mm
- Maximum Door Height : 2100mm
- Maximum Door Weight : 80kg.
- Base Material Casting : Metal Alloy Body
- Suitable Glass Thickness : 10mm / 12mm.
- Finish :- SSS

NGSF - 01 Roller For Sliding Glass Door

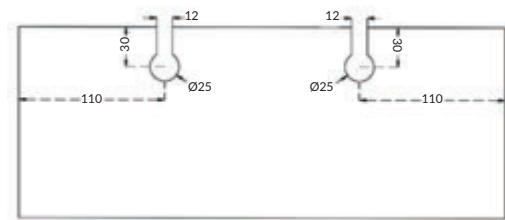

Glass Preparation

Features:

- Trouble Free Operation.
- Maximum Door Width : 1050mm
- Maximum Door Height : 2400mm
- Maximum Door Weight : 100kg.
- Base Material Casting : Metal Alloy Body
- Suitable Glass Thickness : 10mm / 12mm.
- Finish :- SSS

NGSF - 02 Roller For Sliding Glass Door

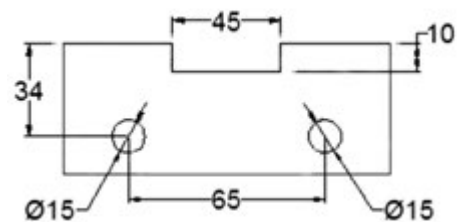

Glass Preparation

- Trouble Free Operation.
- Maximum Door Width : 1200mm
- Maximum Door Height : 2600mm
- Maximum Door Weight : 120kg.
- Base Material Casting : Metal Alloy Body
- Suitable Glass Thickness : 10mm / 12mm.
- Finish :- SSS

NGSF - 03 Roller For Sliding Glass Door

GLASS SLIDING FITTING



Features:

- Material : Stainless Steel
- Finish :- SSS

NGSF - 11 Wall to Track "L" Connector



NGSF - 12 End Bracket for Fixing Track into Wall



NGSF - 13 Stopper for Sliding Roller
NGSF - 01 / 02 / 03.



Features:

- Material : Stainless Steel
- Suitable Glass Thickness : 8mm / 10mm / 12mm.
- Finish :- SSS

NGSF - 14 Floor Guide (Oval)



Features:

- Material : Stainless Steel
- Finish :- SSS / PSS

NGSF - 15 Half Round Door Stopper

GLASS SLIDING FITTING - ALUMINIUM TRACK

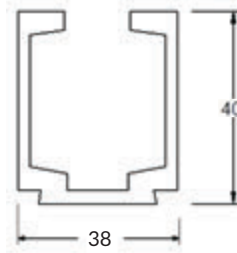

Features:

- Material :- Aluminum
- Size :- 12 Feet
- Finish :- ALU

NAT - 01 Single Track for NGSF - 01 / 02 / 03

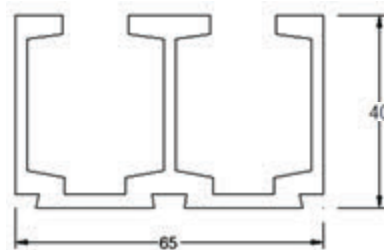

Features:

- Material :- Aluminum
- Size :- 12 Feet
- Finish :- ALU

NAT - 02 Double Track for NGSF - 01 / 02 / 03

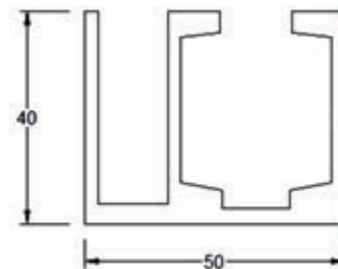

Features:

- Material :- Aluminum
- Size :- 12 Feet
- Finish :- ALU

NAT - 03 Single Track with One Side Fix for NGSF - 01 / 02 / 03

GLASS SLIDING FITTING



GLASS SLIDING FITTING - S.S. 304

Shower Sliding System - NSGSF - 01 (S.S. 304)



NSGSF - 01 A



NSGSF - 01 B



NSGSF - 01 C



NSGSF - 01 D



NSGSF - 01 E



NSDH - 02



NSH - 416



NSGSF - 01 Set Includes:

- | | | |
|---------------------|----------------------------------|--------|
| NSGSF - 01 A | : Sliding Door Roller - | 2 Pcs. |
| NSGSF - 01 B | : Track to Fix Glass Connector - | 2 Pcs. |
| NSGSF - 01 C | : Wall Socket - | 2 Pcs. |
| NSGSF - 01 D | : Stopper - | 2 Pcs. |
| NSGSF - 01 E | : Floor Guide - | 1 Pc. |
| NSDH - 02 | : Sliding Handle - | 1 Pc. |
| NSH - 416 | : Rectangle Track - 2 Mtrs. - | 1 Pc. |

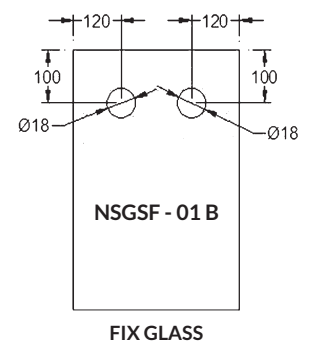
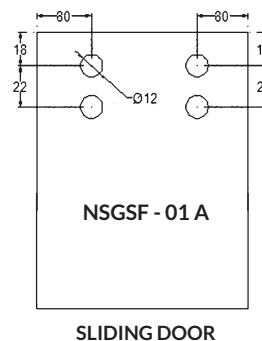

GLASS PREPARATION

GLASS SLIDING FITTING - S.S. 304

Shower Sliding System - NSGSF - 02 (S.S. 304)



NSGSF - 02 A



NSGSF - 02 B



NSGSF - 02 C



NSGSF - 02 D



NSGSF - 02 E



NSGSF - 02 F



NSDH - 02



NSH - 416



NSGSF - 02 Set Includes:

- | | | |
|--------------|----------------------------------|--------|
| NSGSF - 02 A | : Sliding Door Roller - | 2 Pcs. |
| NSGSF - 02 B | : Roller Support - | 2 Pcs. |
| NSGSF - 02 C | : Track to Fix Glass Connector - | 2 Pcs. |
| NSGSF - 02 D | : Wall Socket - | 2 Pcs. |
| NSGSF - 02 E | : Stopper - | 2 Pcs. |
| NSGSF - 02 F | : Floor Guide - | 1 Pc. |
| NSDH - 02 | : Sliding Handle - | 1 Pc. |
| NSH - 416 | : Rectangle Track - 2 Mtrs. - | 1 Pc. |

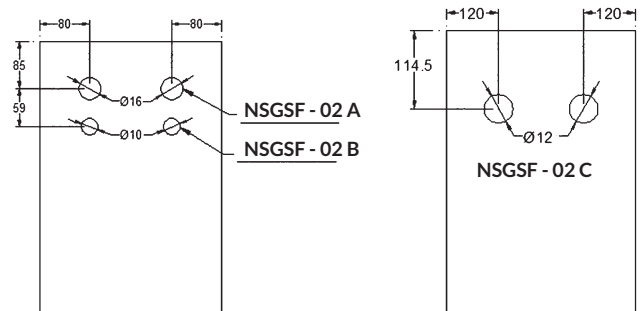

SLIDING DOOR

FIX GLASS

GLASS PREPARATION

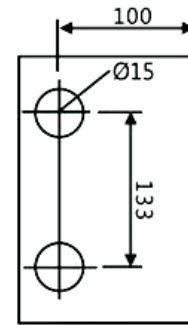

Glass Preparation

Features:

- Material : S.S. 304
- Suitable Glass Thickness : 10mm / 12mm.
- Finish :- SSS / PSS

NSDH - 01 Sliding Door Handle - Rectangle

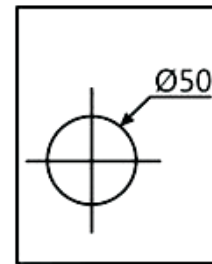

Glass Preparation

Features:

- Material : S.S. 304
- Suitable Glass Thickness : 10mm / 12mm.
- Finish :- SSS / PSS

NSDH - 02 Sliding Door Handle - Round

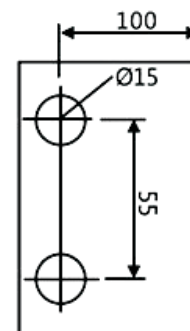

Glass Preparation

Features:

- Material : S.S. 304
- Suitable Glass Thickness : 10mm / 12mm.
- Finish :- SSS / PSS

NSDH - 03 Sliding Door Handle - Square

Glass Architectural Hardware

The technical presentations and dimensions in the illustrations and drawings are non binding. We reserve the right to make changes to specifications at any time. We do not accept any responsibility for any errors which may occur in the production of this catalogue. All sizes in millimeter (mm).

The products in this list are the ones that are currently in the NSA product range. Since our product range is updated frequently, please feel free contact us if you cannot find any particular information.

The printed colours indicating the surface finishes are not 100% true, but do provide a useful guide.

Pictures may show designs which are different to the scope of delivery.



INNOVATION WITH INTEGRITY

Marketed by :

N. S. Enterprises

C-8, Room No. 4/5, Opp. Ram Mandir,
Bhadran Nagar, S. V. Road,
Malad (W), Mumbai - 400 064.

Tel. : +91 22 2807 6175

Email : ns_enterprise@yahoo.co.in

Website: <https://nsaenterprise.com> | <https://www.indiamart.com/n-senterprisesmumbai/>